

SAM

Star Adventurer Mini User Guide

Copyright Sky-Watcher Telescopes Inc.

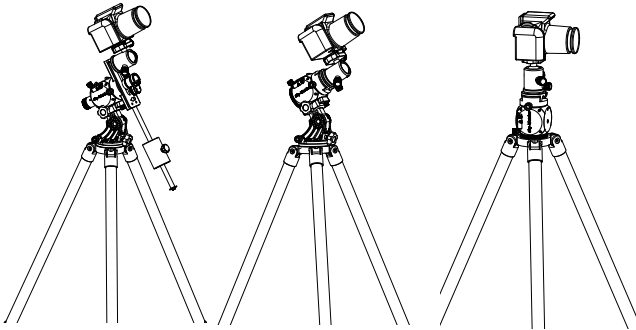
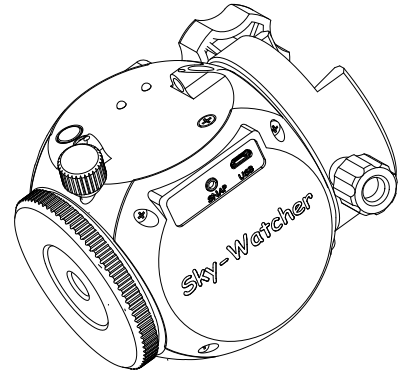

- Astrophotography
- Time-Lapse Photography
- DSLR Camera Control

Quite Possibly The Most Compact and Versatile Camera Tracking Platform in the Known Universe!

Sky-Watcher®
Be amazed.

Thank You For Purchasing This Sky-Watcher Product

The Sky-Watcher Star Adventurer Mini (SAM) is a compact high-precision camera tracking platform that is ideal for long exposure astrophotography as well as time-lapse photography in daytime and nighttime settings. SAM easily fits in your backpack or camera bag, making it a convenient travel companion that can venture with you into remote locations. SAM comes with built-in WiFi and the free Star Adventurer mini Console App for Android and iOS platforms. SAM is easy to set up and easy to operate in all of its modes. The more you use it, the more you'll love it!

For your Safety

To prevent damage to your Sky-Watcher product or injury to yourself or to others, all users of this product should first read the following safety precautions entirely before using this equipment.

WARNING:

- Do not look at the sun through the polar scope. Viewing the sun or other strong light sources through the polar scope could cause permanent visual impairment.
- Do not use in the presence of flammable gas. Do not use electronic equipment in the presence of flammable gas, as this could result in explosion or fire.
- Keep out of reach of children. Failure to do so could result in injury. Moreover, note that small parts constitute a choking hazard. Consult a physician immediately if a child swallows any part of this equipment.
- Do not disassemble. Touching the product's internal parts could result in injury. In the event of malfunction, remove the battery and take the product to a Sky-Watcher authorized service center.

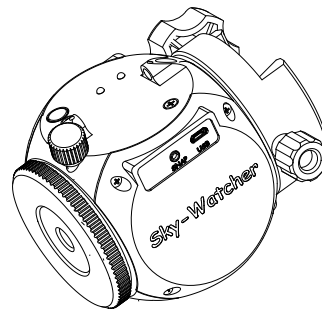

“ Take your photographic creativity to new heights with the most compact and multi-featured camera tracking platform available in the galaxy! ”

Features:

- High precision, portable and stable camera tracking system
- Built-in WiFi with free app for Android and iOS platforms
- Multi-language support
- Solar, lunar and sidereal tracking rates for astrophotography
- Payloads up to 3kg
- Easy Polar Alignments with polar scope
- Supports Star-Scape photography
- Supports standard short exposure time-lapse photography
- Supports long exposure time-lapse photography
- Supports Star-Scape time-lapse photography
- Provides DSLR shutter control for multiple brands
- Lifetime FREE firmware upgrades
- Built-in motor protection and status indicators
- Power Options: AAx2 Batteries or external USB supply
- Fits standard 3/8 and 1/4 inch tripod/quick release brackets
- Expandable with a range of optional accessories

Contents

Introduction and Safety Considerations	2	Polar Alignment	19
SAM's Main Features	3	Polar Alignment in the Northern Hemisphere	20
SAM's Parts Diagram	5	Polar Alignment in the Southern Hemisphere	21
Optional Accessories	6-7	Star Adventurer mini Console for Astrophotography	21
Overview and Preliminary Setup	8	Astrophotography Progress Screen	22
Installing the Star Adventurer mini Console	8	Using SAM for Astro Time-Lapse Photography	23
Power-up, WiFi and Status Indicators	8-9	Astro Time-Lapse Progress Screen	24
Setting Up For Time-Lapse Photography	10	Manual Control of SAM	26
Attaching SAM To Your Tripod	10	Settings Menu	27
Mounting Your Camera Gear to SAM	10	WiFi Network	28
Star Adventurer mini Console for Time-Lapse	11	Network Trouble-Shooting	29
Time-Lapse Photography Parameters	12	APPENDICES	
Keep it Simple to Start	12	I Advanced Polar Alignment Procedures	30
Time-Lapse Parameter Details	13-14	II Calibrating the Polar Scope	36
Time-Lapse Progress Screen	15	III Using the Equatorial Wedge	39
Astrophotography and Astro Time-Lapse	16	IV Using the Fine-Tuning Mounting Assembly	40
The Need For Long Exposures	16	V Firmware Upgrade Procedures	42
The Need For Tracking	16	VI How to Restore Factory WiFi Settings	43
Astro Time-Lapse	17	VII SAM Specifications	44
Astrophotography Special Requirements	18		

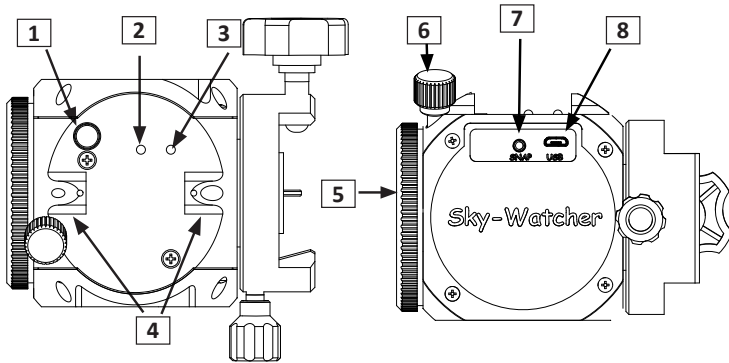

SAM Parts Diagram

- 1: Power Button
- 2: Power LED Indicator
- 3: WiFi LED Indicator
- 4: Polar View Finder
- 5: Knurled Tripod Connector
- 6: Tripod Connector Locking Knob
- 7: SNAP Port: DSLR Shutter Control
- 8: Micro USB Port
- 9: AA x 2 Battery Case
- 10: Saddle
- 11: Dovetail Locking Knob
- 12: Saddle Locking Knob
- 13: 1/4" to 3/8" Thread Adapter
- 14: 3/8" Threaded Side Socket
- 15: 3/8" Threaded Base Socket

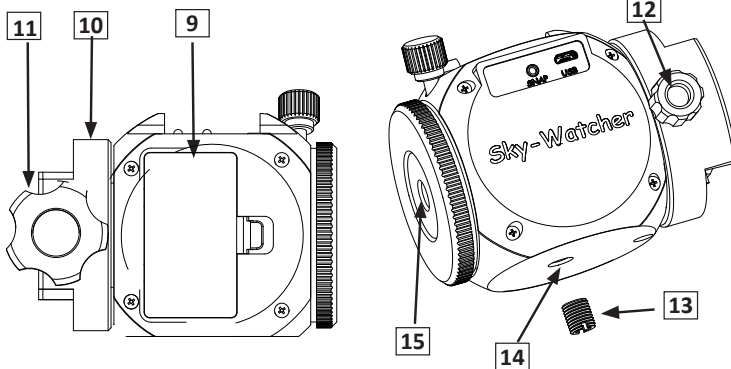

SAM Included and Optional Accessories

Please Note: Included accessories may vary by dealer.

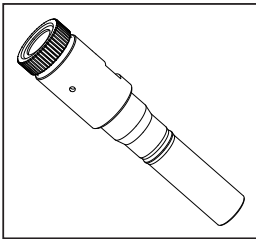

Polar Scope: Included

Enables very precise polar alignments for long exposure astrophotography yielding pinpoint stars over longer exposures.

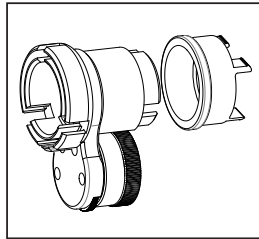

Polar Scope Illuminator: Included

Illuminates the polar scope to make the polar scope reticule easier to see in darkness.

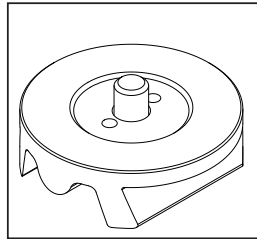

3/8" Ball Head Adapter: Included

SAM INCLUDES a 3/8" Ball Head Adapter to mount a standard camera ball-head with a 3/8" thread attachment.

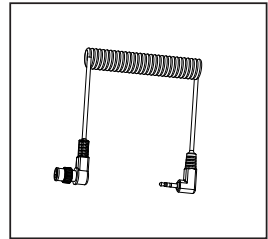

DSLR Control Cable: Optional

Refer to the table on the next page to identify the correct cable for your DSLR.

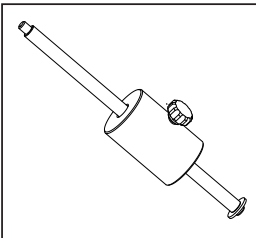

Counterweight Kit: Optional

1 kg counterweight system to balance and/or increase payload capacity up to 1kg..

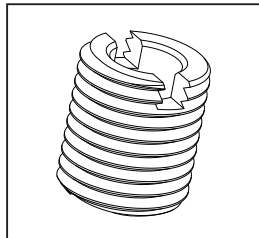

1/4" to 3/8" Thread Adapter: Included.

Converts the default socket for 3/8" thread screw to 1/4" in order to mount SAM to a standard quick release plate or tripod with a 1/4" threaded bolt.

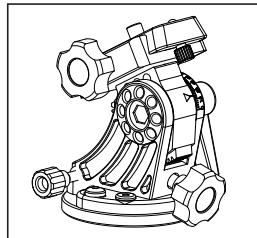

Equatorial Wedge: Optional

Provides easy, high precision pointing of SAM for polar alignment with more stability than a standard photo tripod head.

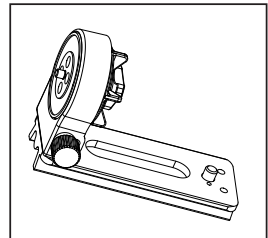

Fine-Tuning Mounting Assembly

This **optional** accessory enables coarse and fine pointing in two directions for precise aiming control. See Appendix IV for details.

SAM Optional and Included Accessories

Please Note: Included accessories may vary by dealer.

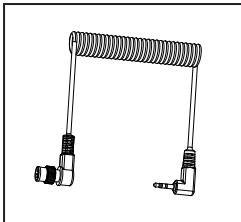

DSLR Control Cable

Controls the shutter of your DSLR. Available for Canon, Nikon, Olympus and Sony cameras. See the table below to select the appropriate cable for your camera model.

Part Number	Camera Interface Style	Controller Interface	Compatible Camera Models
AP-R1C	Canon remote (E3 type)	Canon RS-60E3	Canon EOS 100D, 300D/350D, 400D/450D, 500D/550D, 600D/650D, 700D, 60D/60Da, 70D
AP-R3C	Canon remote (N3 type)	Canon RS-80N3, TC-80N3	Canon EOS 5D/6D/7D, 10D/20D/30D/40D/50D, 1V, 1D, 1Ds Mark III, 5D Mark III
AP-R1N	Nikon 10-pin remote terminal	Nikon MC-22, MC-30, MC-36	Nikon D1/D2/D3/D4 D200/D300/D700/D800
AP-R2N	Nikon remote cord connector	Nikon MC-DC1	Nikon D70S, D80
AP-R3N	Nikon accessory terminal	Nikon MC-DC2	Nikon D90, D600, D3000/D3100/D3200/D3300, D5000/D5100/D5200/D5300, D7000/D7100
AP-R1S	Sony remote terminal	Sony RM-S1AM, RM-L1AM	Sony a100, a200, a300, a350, a450, a550, a560 a700, a850, a900
AP-R3L	Olympus multi-connector	RM-UC1	Olympus E-P1/E-P2, E-PL2/E-PL3, E510/E520/E550/E620, E400/E410/E420, SP-570UZ/SP-590UZ

Overview: Preliminary Set Up

SAM is a compact and versatile camera tracking platform that lets you make truly unique photographs and time-lapse videos. The high precision motor rotates your camera to pan across any angle you desire giving you full creative control over your time-lapse composition.

For astrophotography, SAM's precise sidereal tracking enables long exposures to capture brilliant colour and detail in dim nebulae and star clouds while maintaining pin point star images. Use SAM to capture stunning starscapes, or to make portraits of your favourite constellations. You can even configure SAM's astrophotography time-lapse functions to record the progress of a lunar eclipse!

SAM features full shutter control for many DSLR cameras along with many other functions by means of the free Star Adventurer mini Console – available for your Android or iOS device. With its high precision tracking and powerful free app, SAM gives you a new tool with countless creative possibilities.

And now it's time to get to know SAM in more detail! Please read each section carefully to understand how to set SAM up for a particular application and how to control SAM using the free control app.

Installing the Star Adventurer mini Console

The Star Adventurer mini Console is available at the Android "Play Store" and at the "App Store" for your iOS device. Go to your particular store, search for "Star Adventurer mini Console", then download and install. The app performs the same way for both operating systems. Detailed use of the app is provided in the relevant sections.

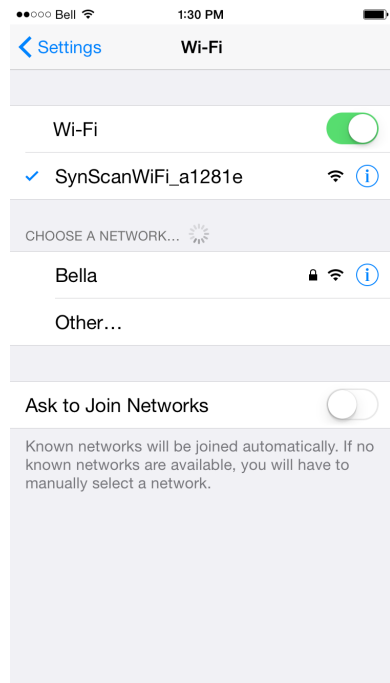

LED Status Indicators

Red LED Off: The Power is Off.

Red LED Solid On: Power is on and system is normal.

Red LED Slow Blink: Low Battery Level / Firmware Update in Progress. The red LED blinks 2 times per second when the battery level is lower than 2.3V, or during firmware upgrades.

Red LED Fast Blink: The red LED blinks 3 times per second to indicate motor speed errors exceeding 5% and/or motor stalls that last over 5 seconds. Speed errors can be caused by overloading the mount and by low battery levels. To correct a speed error reduce the load or supply new batteries. Motor stalls are usually due to obstructions of the mount so that it cannot rotate. In the case of motor stalls, remove the cause of the block then restart your task.

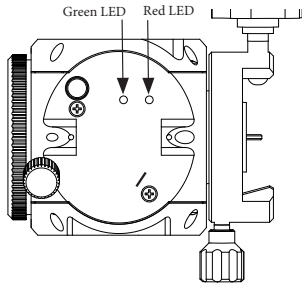

Green LED Off: WiFi is turned off.

Green LED Blinking: WiFi is activated and ready for connection.

Green LED Solid On: WiFi is connected and Star Adventurer mini Console is running.

View Finder LED Blinking: Current photography process has finished. Cleared after APP re-connects.

Basic Power Up, WiFi Connection and Status Indicators

This section describes the basic power up and WiFi connection for SAM. Details on how to physically set up SAM for specific uses (e.g., astrophotography) is provided in the relevant sections. Please familiarize yourself with the basic power up procedures and status indicators before moving on to more advanced uses.

Power Sources: SAM can be operated with 2x AA type batteries or via USB from a 5v AC/USB adapter or USB port of a computer. NOTE: You will need to supply power to SAM by one or the other of these methods in order to confirm the details you read in this section.

Power On: Push and hold the power button until the red Power LED lights up. The Polar View Finder LED will also light up, and the green WiFi LED will start to blink indicating that the built-in WiFi is activated and ready for connection.

Connect to WiFi: Once power is applied, go to the “Settings > WiFi” for your phone, then search for and join the WiFi access point “SynScanWiFi_xxxxxx”.

Start the Star Adventurer mini Console: Once WiFi is connected you can run the Star Adventurer mini Console to access its many features. See specific details in the relevant sections.

Power Off: Push and hold the Power Button for about 5 seconds to turn off the power.

Reconnecting the WiFi After a Timeout: In the absence of WiFi traffic the built-in WiFi will be turned off and the green WiFi indicator light extinguished. The default time-out is 10 minutes but you can set it to other values using the Star Adventurer mini Console. To resume WiFi, press the power button briefly until the green WiFi LED comes back on, then release the power button. Re-connect to

the WiFi as described above.

Refer to the sidebar for a detailed description of all status indicators.

Setting Up SAM

Before SAM can be used for a particular application (e.g., astrophotography) it needs to be mounted on a tripod, have the camera gear attached, and then be configured using the Star Adventurer mini Console. The following sections explain how to do these things for regular-exposure time-lapse photography, long-exposure time-lapse photography and astrophotography.

Setting Up SAM for Regular-Exposure Time-Lapse Photography

Attaching SAM To Your Tripod

Set up your tripod according to the directions it came with. Ensure it is stable and set at the height you wish to use it.

For regular-exposure time-lapse photography SAM is mounted directly to a level tripod via the 3/8 inch tripod mounting bolt. Your tripod may have a ball head or pan-tilt head attached. We recommend you remove this and attach SAM directly to the tripod using the 3/8 inch threaded base socket that is on the side opposite the saddle (see top photo on this page).

Mounting Your Camera Gear

Now you can attach your camera gear (see bottom photo). Note that an optional ball mount is shown. This is a highly recommended option to give you far more creative control when composing your shots.

Once SAM is attached to your tripod, and your camera gear is attached to SAM, you are ready to start making videos with the Star Adventurer mini Console.

The last step is to attach SAM to your camera using the SNAP cable. One end plugs into the port for a wired shutter remote on your camera and the other into the SNAP port on SAM.

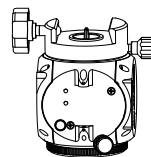

Attach to tripod via 3/8 inch base socket.

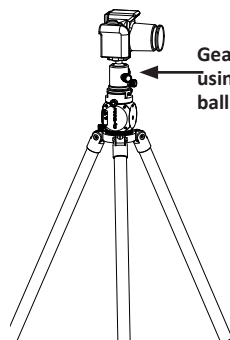
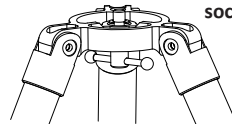

Gear mounted using optional ball mount.

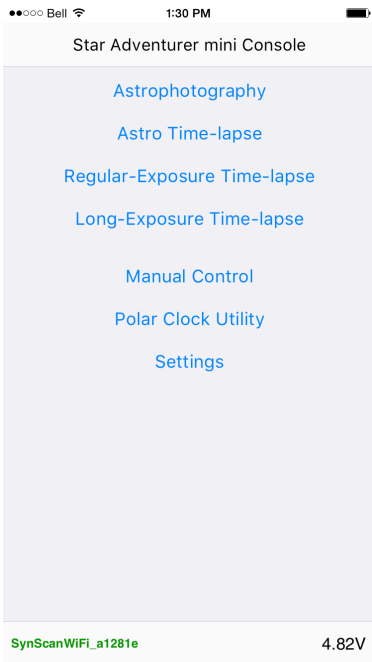

Time-Lapse Photography with the Star Adventurer mini Console

Now that you have SAM set up with your camera gear attached it's time to learn how to use the Star Adventurer mini Console. This section assumes that you installed the app on your device. If you have not, please refer back to the section titled *Installing the Star Adventurer mini Console*.

The main screen of the control app divides SAM's functions into separate sections. To select a function just tap on it. There are separate sections for astrophotography and for different types of time-lapse photography. The app also provides for *Manual Control* of SAM, assists you with *Polar Alignment* (see astrophotography section), and lets you alter *Settings*, such as making a WiFi connection with SAM.

For now, select *Regular-Exposure Time-Lapse* by tapping on it. This is the simplest mode for SAM and a good one for helping you understand how to set the control options. *Regular-Exposure Time-Lapse* mode is for capturing time-lapse videos under daylight or well-lit conditions where long exposure times are not necessary. In this mode, exposure settings are set on your camera. The Star Adventurer mini Console pans your camera and sends signals to trigger the shutter as it creates your time-lapse video.

In the *Long-Exposure Time-Lapse* mode SAM controls the exposure time instead of your camera. This way you can use exposures that exceed 30 seconds, which are often needed in low light conditions, especially with small aperture settings on your lens. Whenever you use *Long-Exposure Time-Lapse* mode set your shutter to BULB mode. If it is not set on BULB mode the camera shutter speed setting will be used instead.

You can make time-lapse videos using SAM to control the shutter only (no panning), or to pan continuously while firing the shutter of your camera at intervals set by you. Use the first of these techniques to produce a time-lapse video from a fixed perspective and the second to create a time-lapse video in which the perspective changes as the video is recorded.

Regular and Long-Exposure Time-Lapse Parameters

The major difference between *Regular-Exposure Time-Lapse* mode and *Long-Exposure Time-Lapse* mode is that, in the latter case, rotation stops during the exposure. This enables the sensor to capture more of the available light resulting in a better image.

The parameters for *Regular-Exposure Time-Lapse* and *Long-Exposure Time-Lapse* are exactly the same except for the *Exposure* parameter. In the *Regular-Exposure Time-Lapse* screen you cannot change the value for *Exposure*. It is fixed at 0.5 seconds, which is a requirement in order for SAM to provide an adequate signal to control the shutter of your camera. Note: This 0.5 second period is automatically taken into consideration when the App calculates the *Video Time Span* parameter.

In the *Long-Exposure Time-Lapse* mode the *Exposure* parameter controls the T_v (exposure time) setting of your camera and can be set to suit your needs. For night scenes where a small aperture and low ISO value is used, individual exposures may range from a second or two to several minutes. Take some test shots to establish the best settings and exposure for your needs, then enter that value into the *Exposure* parameter field. Again, you must set your shutter to BULB mode, otherwise the T_v setting on your camera will take precedence over the value in the *Exposure* field.

The screen shot on Page 13 shows the various

parameters that you can set to create your time-lapse video, with a few more that can be seen by scrolling down (see page 14). All of the parameters are explained in detail below. To start the time-lapse sequence just press *Run* once all of your parameters have been set. If you are particularly happy with a set of parameters you can save them in a profile and recall them again whenever you like.

Keep it Simple to Start

The simplest way to get started is to set SAM up on a tripod and take a static Time-Lapse Video (one that doesn't involve panning). To do this, all you need to know is the time span over which your video will be taken and the length of your final video.

For instance, if you want to get a time-lapse video of the last hour leading to sunset, enter a value of 1 for *Video Time Span*. If you want to compress that hour into a 45-second long video, set your *Video Length* to 45. It's that easy. SAM's powerful app will calculate the other necessary parameters for you.

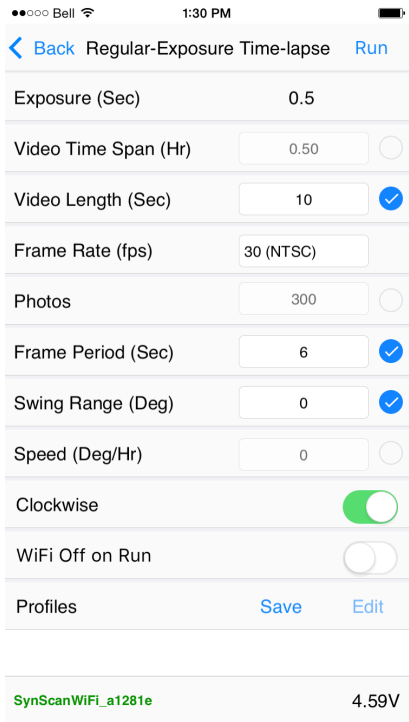

Time-Lapse Parameter Details

Following is a complete list of the parameters you can set. Note that because several of the parameters are interrelated some may be unavailable at certain times. For instance, when *Frame Rate* and *Video Length* are set you cannot manually choose the number of *Photos* as it is calculated for you based on the other two parameters. However, if you deselect *Video Length* and set *Photos* directly, the app will calculate a new value for *Video Length*.

Exposure (Sec): Fixed at 0.5 seconds for *Regular-Exposure Time-Lapse*. For *Long-Exposure Time-Lapse* set this value to suit your exposure requirements. Be sure to set your camera shutter to BULB mode.

Video Time Span (Hr): Set this parameter to the total *Video Time Span* time for your video. For example, if you want your video to cover a span of three hours, set *Video Time Span* to 3. Note that *Video Time Span* does not refer to the length of your video, it refers to the time span over which it is created. You set the desired length of your video in the *Video Length* parameter.

Video Length (Sec): Set *Video Length* equal to the desired length of your video in seconds. For a one-minute long video, set *Video Length* to 60.

Frame Rate (fps): Select *NTSC (30 fps)* or *PAL (25 fps)* according to the video standards for your location. You can further adjust the playback speed of your video in your video editing software.

Photos: This parameter is automatically set by setting *Video Length* and *Frame Rate* using the formula: $Photos = Video\ Length \times Frame\ Rate$

Frame Period (Sec): You can set the *Frame Period* to select a desired interval between photos taken rather than have it calculated for you based on other parameters. Note that if you set *Photo Interval* and *Video Length* the app will re-calculate *Video Time Span*. Anytime you are changing a parameter it is a good idea to check its effects on the other ones.

Swing Range (Deg): Use *Swing Range* to create an interesting swing or pendulum effect for your time-lapse video. When used, SAM will pan to the limit of the *Swing Range* that you set, then pan back to your starting point as many times as specified in the *Swing Count* parameter. For instance, say you have two interesting subjects that you want to feature in your video. Set *Swing Range* to the angle between them and *Swing Count* to 1, then point your camera at the first subject. As the time-lapse video is being recorded, SAM will pan from the first subject to the second subject then stop. By setting *Swing Count* to 2, it will pan to your second object, then back to your first object, then stop. By using *Swing Range* values greater than 1 you can have SAM pan back and forth multiple times during the video. Set *Swing Range* to 0 for no panning and to an even number to always end up where you started.

Speed (Deg/Hr): *Speed* determines how quickly SAM will pan. In most cases, you do not need to set this parameter unless you want to control the panning speed but are not concerned with the actual video time span. If you do not want SAM to pan in your time-lapse video then set *Speed* to 0.

Clockwise: *ON* will cause SAM to rotate left to right (viewing down with the saddle on top). *OFF* will cause SAM to rotate right to left.

WiFi Off on Run: When enabled, SAM will automatically turn off WiFi at the start of a task to save power. WiFi can be restored at any time by pressing and holding the power button until the green LED WiFi indicator light comes on.

Profiles Save / Edit: To save a profile tap *Save*. To edit or delete a profile tap *Edit*. You can store multiple profiles of your favourite settings for recall at future sessions.

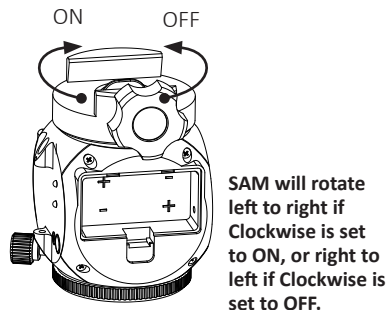
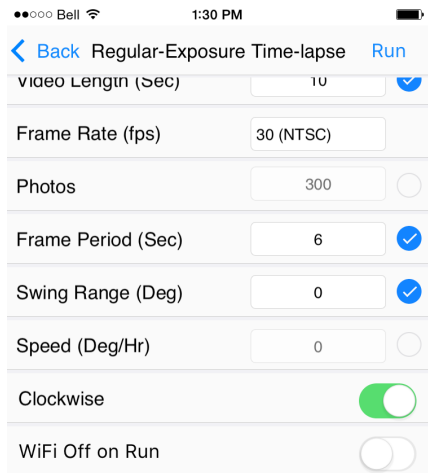

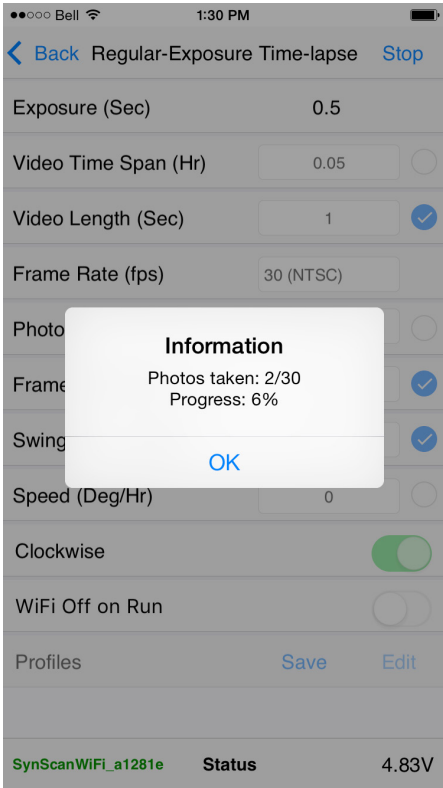

Time-Lapse Progress Screen

Once your tripod, SAM and camera gear are set up and all of your task parameters are set, just press *Run* to initiate the task. Your parameter settings will remain in view and *Status* will appear at the bottom of the screen. To view the task progress tap on *Status*.

Pressing *Stop* brings up a confirmation screen. You can cancel the *Stop* request and resume the task or proceed to end the task at that point.

The *Long-Exposure Time-Lapse* progress screen shows the same information and works in the same manner.

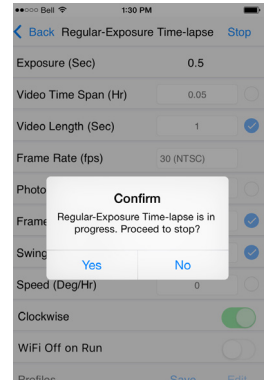

Astrophotography and Astro Time-Lapse

Astrophotography

Astrophotography refers to photography of the night time sky. It has become far more familiar to us due to the incredible images recorded by the Hubble Space Telescope and shared by NASA with the public over the past two decades. But astrophotography didn't start with the Hubble Space Telescope. In fact, it started more than 100 years ago and has been done in large part since that time by *amateur* astronomers.

With SAM, astrophotography is now something you can do, too. You won't be able to produce photographs that have the same image scale as those taken by the Hubble, but you will be able to make beautiful portraits of constellations and large regions of the Milkyway galaxy showing star clouds, star clusters, and light and dark nebulae. You'll be able to record time-lapse videos of auroras, and the stages of a lunar eclipse.

First, however, there are two challenges to overcome that you don't encounter in typical, terrestrial types of photography. One is the need to use long exposures (e.g., greater than 30 seconds) to record dim night sky objects. The second is the need to have the camera follow the sky as the exposure is taking place.

The Need For Long Exposures

Unfortunately, you can't just set your camera to AUTO, aim it at the night sky and take a picture. The night sky is far too dim for that to work, and any attempts you make will produce seriously underexposed results. But, you can overcome this challenge by selecting BULB mode on your camera and using SAM's SNAP cable



The MilkyWay Galaxy revealed through a long exposure astrophoto with precision tracking.

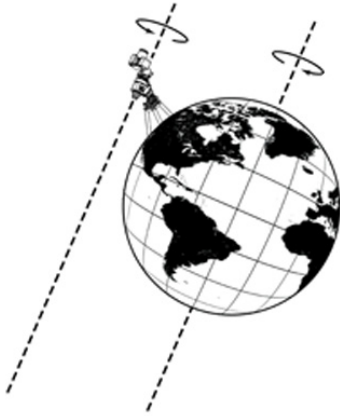

An equatorial mount rotates to prevent star trailing in your photo by precisely countering Earth's Rotation.

connection to create much longer exposures – like a minute or two – or ten! With a sufficiently long exposure, your camera will collect enough light to reveal hidden details that are much too faint for our eyes to see. But then, quite literally, you'll see the second problem!

The Need For Tracking

In your now, nicely exposed photo, the stars don't look like stars anymore – they look like little lines and arcs of variable lengths! The problem here is called trailing, and it becomes more noticeable as the focal length of your lens and/or your exposure time increases.

You might think that trailing is due to the movement of the stars, but it's not. It's due to the movement of your camera as it records those distant stars over the course of that exposure. Your camera is moving because it is sitting on a tripod that is sitting on the Earth, and the Earth is rotating. This motion causes the stars, which appear to be fixed in space from our perspective, to appear to move relative to us, and more importantly, to our camera.

SAM overcomes this challenge by moving your camera to precisely offset the effects of Earth's rotation while a sufficiently long exposure of the night sky is being made. SAM's tracking capability keeps a specific area of the sky impinging upon the same part of the camera sensor throughout the exposure. So a star will fall on the same set of pixels from the beginning through the end of the exposure. The result is a well-exposed photo of the night sky with pin point star images.

With SAM, two of the biggest challenges in doing astrophotography are simplified and automated for you. SAM's camera control features enable you to take exposures in excess of 30s each. SAM's tracking ability keeps your camera on target to produce pin point star images. As your skill level in astrophotography progresses you can set SAM up to take multiple images of your subject, then use advanced processing techniques like stacking to make truly remarkable celestial portraits.

Astro Time-Lapse

Astro Time-Lapse photography faces the same challenges as astrophotography in general. Namely, due to the dimness of the subject (the night sky), longer exposures are required to record sufficient detail, and tracking is needed to prevent star trailing during those exposures. But there are some differences as well.

For astrophotography, the region of sky that is being photographed moves over the course of the exposure sequence. We generally repeat the process to obtain a sequence of images, all of the same subject, and all framed identically. This means that our camera is pointing in a different direction at the end of the sequence compared to where it was pointing at the beginning. This occurs because our subject has moved and the camera has moved along with it.

In *Astro Time-Lapse* we take multiple images as well, and the camera moves with each exposure. But, unlike in astrophotography, SAM returns the camera to the starting point after each exposure is completed.

Now, when the frames are sequenced into a video, you see the night sky moving about a fixed terrestrial reference point. By finding locations with beautiful foreground settings you can produce breathtaking videos of the sky moving over your location. [Visit our YouTube channel to see some examples].

Special Requirements For Astrophotography and Astro Time-Lapse

In order to track the movement of the night sky the camera has to be continuously moved to offset the rotation of the Earth in order to hold the subject perfectly steady on the sensor. The rotation of the camera needs to take place about an axis that is parallel to Earth's rotational axis, and therefore, the two axes must be aligned in order for tracking to work correctly.

A time-lapse video consists of hundreds to thousands of individual photos taken over a long span of time then replayed in a short video, revealing natural dynamics that occur much too slowly for us to perceive otherwise.

Look through the Polar View Finder and align on Polaris, making adjustments with your tilt/pan head or ball mount.

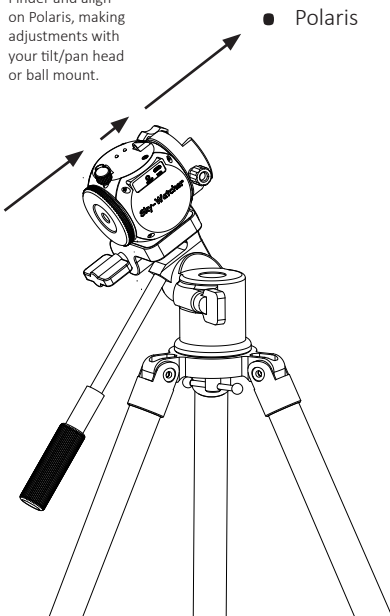

Polar Alignment

Polar Alignment refers to the procedure for aligning SAM's rotational axis with the Earth's rotational axis. If we extend Earth's rotational axis into space it intersects an imaginary point called the Celestial Pole. In the Northern hemisphere we refer to that point as the North Celestial Pole, or NCP for short. In the Southern hemisphere it is the South Celestial Pole or SCP.

Because the celestial poles are imaginary points, there is nothing to see at their locations. This can make pointing at them a bit of a challenge! However, there are a couple of celestial land marks nearby the poles that help us along. In the north it is Polaris, the North Star. In the south it is the star Sigma Octanis.

Polar Alignment in the Northern Hemisphere

To polar align SAM with the NCP follow this procedure. It is best to do this at dusk when you can just see Polaris, but before it is completely dark so that you can more easily see what you are doing. Also, it's always good practice to save the dark for taking your pictures, not for setting up your equipment. The following steps assume you have a tilt/pan head or ball mount attached to your tripod:

1. Set up your tripod and be sure that it is secure.
2. Attach SAM to the tilt/pan or ball head. The Polar View Finder should be on top and the saddle facing north.
3. Now, angle the tilt/head or ball mount up and rotate so that you can see Polaris in the field of view of the Polar View Finder. This is all you will need to do when using short focal length lenses and/or exposures that are only a few seconds long. If you are using longer focal length lenses (e.g., greater than 100 mm or so) or exposures exceeding 30 – 60s then you may get better results by following the steps outlined in Appendix I: Advanced Polar Alignment Procedures.

If you are using the optional Equatorial Wedge attached to your tripod, follow this procedure:

1. Set up your tripod and ensure it is stable.
2. If you have a tilt/pan head or ball mount it is best to remove it from your tripod. Attach the Equatorial Wedge directly to your tripod via the 3/8-inch threaded mounting hole.
3. Once the wedge is securely attached align the tripod so that the Altitude Adjustment Knob is facing north.
4. Now, level your tripod using the built-in Bubble Level. A level equatorial wedge is not a requirement for astrophotography, but it makes subsequent adjustments easier to make.
5. Once level, rotate the Altitude Adjustment Knob until the Altitude Indicator points at your *latitude* on the Altitude Scale. (The altitude of Polaris above the horizon at your location matches your latitude). If you don't know your latitude you can look it up in the Star Adventurer mini Console under Settings: Location.
6. Next, attach SAM to the Accessory Mounting Plate using the 3/8-inch dovetail adapter included with the wedge. The saddle on SAM should be facing north with the Polar View Finder on top aimed toward Polaris. You can illuminate the Polar View Finder by pressing the power switch on SAM, or by setting it to ON inside the Star Adventurer mini Console. While looking through the Polar View Finder port, use the Altitude and Azimuth Adjustment Knobs to make finer adjustments until you can see Polaris in the field of view of the Polar View Finder.
7. Now attach your camera gear being careful not to move the tripod out of its polar aligned position. Connect the SNAP camera control cable between SAM and your camera. Point your camera at your subject, then proceed to set up SAM via the Star Adventurer mini Console.

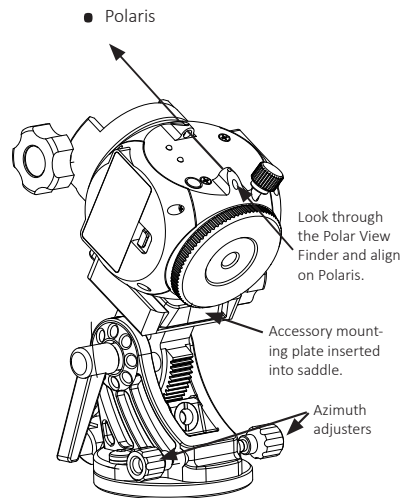

Looking through the Polar View Finder align SAM until you can see the star Polaris in the field of view. This simple polar alignment will be adequate for most purposes.



No Saved Profiles

SynScanWiFi_a1281e

4.76V

You now have your equipment set up and ready to go. Proceed to the section “Using the Star Adventurer mini Console for Astrophotography”.

Polar Alignment in the Southern Hemisphere

The simple polar alignment procedure described above is not possible in the southern hemisphere due to the lack of any bright stars in the vicinity of the SCP. For best results in obtaining an accurate polar alignment, southern hemisphere users should get the optional polar scope to refine their polar alignments. Please refer to *Advanced Polar Alignment Procedure For Users In The Southern Hemisphere* in Appendix I.

Using the Star Adventurer mini Console For Astrophotography

Although astrophotography is technically more challenging than *Regular-Exposure Time-Lapse* photography there are actually fewer parameters to be concerned with. These are described below:

Exposure (Sec): *Exposure* should be set to a value that is sufficiently long to record detail in the night time sky, which is typically longer than 30 seconds. Be sure that your camera is attached to SAM via the SNAP control cable, then set your exposure time in the *Exposure* field. Be sure to set your camera to BULB mode, otherwise your shutter will close according to whatever shutter speed is selected on your camera.

Photo Interval (Sec): Taking multiple long exposures generates a heat build-up in your camera. This heat can increase the amount of grain (noise) in your picture. You can reduce this effect by giving the camera some time to cool down between photos. A good place to start is to set *Photo Interval* to half of the value you set for *Exposure*. SAM will continue to track the object during the *Photo Interval*, then resume with the next exposure once the *Photo Interval* has elapsed.

Photos: Enter the number of photos you wish to acquire of the subject. You can use advanced image processing methods to combine multiple images of an object into a single photo with much less graininess and far more detail than can typically be recorded in a single long exposure.

Tracking Rate: Celestial objects within our own solar system move at slightly different rates than the distant stars and nebulae that populate the rest of our galaxy. SAM can be set to track “nearby” objects more accurately by setting this parameter. Choose *Sidereal* if you are taking a constellation or Milkyway portrait and *Lunar* if you are tracking the Moon (e.g., to record the stages of a Lunar Eclipse). *Solar* is reserved for advanced uses where specialized equipment is being used to photograph the Sun.

WiFi Off on Run: When enabled, SAM will automatically turn off WiFi at the start of a task to save power. WiFi can be restored at any time by pressing and holding the power button until the green LED WiFi indicator light comes on. If you encounter any problems reconnect to SAM’s network on your device.

Profiles Save / Edit: To save a profile tap *Save*. To edit or delete a profile tap *Edit*. You can store your multiple profiles of your favourite settings for recall at future sessions.

Once your tripod, SAM and camera gear are set up and all of your task parameters are set, just press *Run* to initiate the task. This will bring up your *Progress Screen*.

Astrophotography Progress Screen

Anytime you have a process running you can view its progress by tapping on *Status* at the bottom of the parameters screen. This brings up information about number of photos taken, percentage of task complete, etc. The information may vary slightly depending on which function you are currently using.

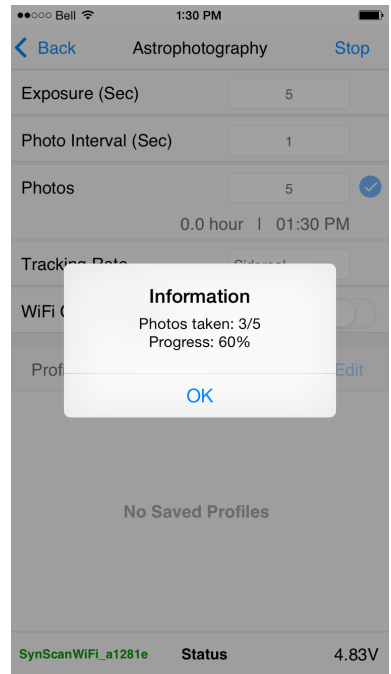

Parameter	Value	Control
Exposure (Sec)	120	Text Input
Video Time Span (Hr)	10.53	Text Input
Video Length (Sec)	10	Text Input (Checked)
Frame Rate (fps)	30 (NTSC)	Text Input
Photos	300	Text Input
Tracking Rate	Sidereal	Text Input
WiFi Off on Run		Toggle Switch
Profiles		Save Edit

No Saved Profiles

SynScanWiFi_a1281e	4.76V
--------------------	-------

Using the Star Adventurer mini Console For Astro Time-Lapse

One of the most unique features of SAM is its ability to create time-lapse videos of celestial vistas. This feature combines SAM's astrophotography functions with its time-lapse functions giving you a powerful tool to create stunning and unique time-lapse videos.

Note that to obtain astronomical time-lapse videos you must polar align SAM as described above. Below are the parameters you can set along with their explanations for producing astronomical time-lapse videos.

Exposure (Sec): *Exposure* should be set to a value that is sufficiently long to record detail in the night time sky, which is typically longer than 30 seconds. Be sure that your camera is attached to SAM via the SNAP control cable, then set your exposure time in this field. Be sure to set your camera to BULB mode, otherwise your shutter will not stay open. It will close according to whatever shutter speed is selected on your camera.

IF YOU TAKE A LONG EXPOSURE AND SEE NOTHING ON YOUR SCREEN THEN MAKE SURE THAT YOUR CAMERA IS SET FOR MANUAL OPERATION, YOUR SHUTTER IS SET TO BULB MODE – AND YOUR LENS CAP HAS BEEN REMOVED.

Video Time Span (Hr): *Video Time Span* refers to the amount of real time that will elapse from the start to the end of the recording. *Video Time Span* is affected by *Exposure*, *Photos*, *Video Length* and *Frame Rate*, and will be calculated for you. However, you can also directly set a value for *Video Time Span*. For instance, if you want to follow the Moon for 5 hours to record the stages of a lunar eclipse, you could set *Video Time Span* to 5. Set the length of your desired time-lapse video in *Video Length* and the appropriate frames per second (fps) in *Frame Rate*. Other related parameters will then be calculated for you.

Video Length (Sec): Set this parameter to the desired length in seconds of your finished time-lapse video. You can set this parameter directly, or you can allow it to be calculated for you based on the values of other parameters.

Frame Rate: Select *NTSC (30 fps)* or *PAL (25 fps)* according to the video standards for your location. You can further adjust the playback speed of your video in your video editing software.

Photos: Enter the number of photos you wish to make up your video. It is usually easier to let this field be calculated based on settings for other parameters. For instance, you have more creative control on your time-lapse video by setting the *Video Time Span* and the *Video Length* parameters, then letting the app calculate the number of *Photos* that will be required.

Tracking Rate: If you are making a time-lapse video of the Moon then select *Lunar*. Otherwise, select *Sidereal*.

WiFi Off on Run: When enabled, SAM will automatically turn off WiFi at the start of the task to save power. WiFi can be restored at any time by pressing and holding the power button until the green LED WiFi indicator light comes on.

Profiles Save / Edit: To save a profile tap *Save*. To edit or delete a profile tap *Edit*. You can store multiple profiles of your favourite settings for recall at future sessions.

Once your tripod, SAM and camera gear are set up and all of your task parameters are set, just press *Run* to initiate the task. This will bring up your Progress Screen.

Astro Time-Lapse Progress Screen

Once your task has started tap *Status* to see information concerning the number of photos completed and time remaining.

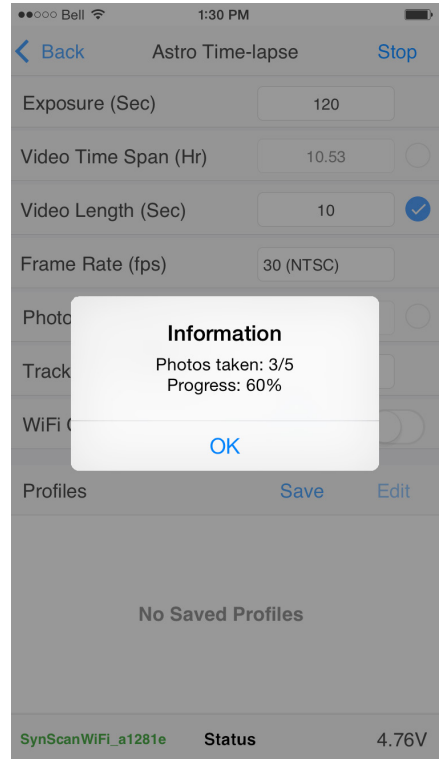

SAM

Star Adventurer Mini User Guide

Part II

Manual Control

Go to the Main Menu and tap on Manual Control. This will bring up the manual control arrows on either side of an angle given in degrees, minutes and seconds. Tap or touch and hold the arrow symbols to nudge or continuously move SAM to the left or right, respectively. Release the arrow symbol to stop SAM's movement. The angle you have rotated through will show up between the arrows.

Manual Control gives you the ability to nudge your camera, but without touching it directly – a handy feature when you need to tweak your composition to get that perfect shot without bumping your gear out of alignment.

You can also use it to determine the Swing Range for your time-lapse video compositions. For instance, say you have two points of interest and want your video to swing from one to the other. Aim your camera at the first point, then Zero the counter. Now, tap and hold the arrow keys until your camera is pointing at your second point of interest. Record the angle that is showing between the arrows and enter it as your *Swing Range* parameter when you are ready to create your time-lapse video.

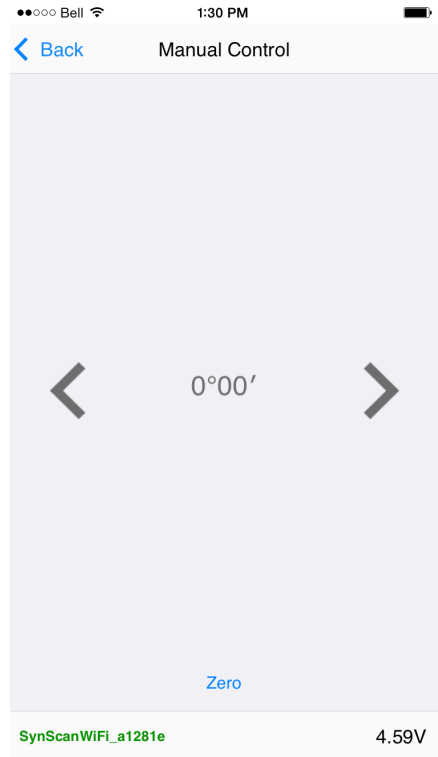

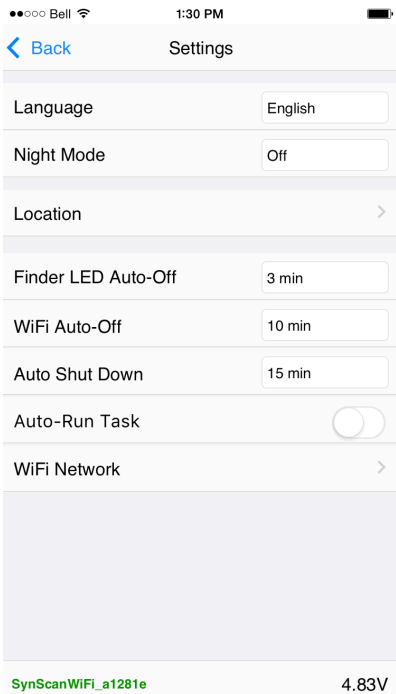

Settings

Tap on *Settings* on the home screen to set a variety of device functions as detailed below.

Language: Choose the default language for the Star Adventurer mini Console.

Night Mode: Tap and choose *On* or *Auto* to get a black background with red text. This mode is designed to help preserve your dark adaptation. Note: if there are any visual astronomers in your vicinity you should set the app to *On* as a courtesy to them.

Location: Tap to get a sub menu that gives you the option to use the location sensor in your device to set your current longitude and latitude. If disabled you can enter the coordinates manually.

Location determines the hemisphere you are in and sets the correct rotation direction for *Astrophotography* and *Astro Time-Lapse* functions. It is also used to display the position of Polaris and Octans on the Polar Scope reticule.

Finder LED Auto-Off: After the selected delay the Polar View Finder LED will automatically turn off. To turn on the LED just quickly press SAM's on/off button, or set the LED to on using the Star Adventurer mini Console.

WiFi Auto-Off: Tap to choose a delay to automatically turn of WiFi to preserve power. WiFi will turn off when no WiFi activity is detected during the Auto-Off interval. You can turn it back on by quickly pressing and releasing SAM's power button. Note: WiFi is not needed once parameters for a given task have been set.

Auto Shut Down: To save power SAM will automatically turn off after the specified amount of time if no tasks are running and there have been no communications between SAM and the control app.

Auto-Run Task: If enabled, SAM will automatically re-start the previous photography process when next time the power is turned on.

WiFi Network

Tap on *WiFi Network* to bring up the WiFi options as detailed below. You can choose either *Access Point (AP) Mode* or *Station (STA) Mode*. Use AP mode for a basic connection to SAM. Use STA mode if you wish to control SAM while simultaneously being connected to a wireless network (e.g., for internet access) or want to control SAM remotely via the internet.

Be sure that you have the correct *STA SSID* and *Password* information. If you enter the incorrect information you may need to reset SAM to its factory settings using the procedure outlined in Appendix VI.

Access Point (AP) Mode: This is the default and simpler mode. In AP mode SAM acts as a wireless access point so that you can connect to it via the Star Adventurer mini Console.

AP Mode SSID: The SSID will automatically show up based on the SSID you entered to make your initial WiFi connection. Select it to connect your device to SAM. Before attempting to connect be sure that SAM is powered up and the green WiFi light is blinking. The green light signals that SAM is ready to make a WiFi connection.

AP Mode Security: Select *Open* if no encryption is to be used. Otherwise, tap on the settings field and choose an encryption type from the list.

Station Mode (STA): Choose this mode if you wish to have internet access while using SAM, control SAM via the internet, or to save battery power. When you select STA mode SAM will join an existing WiFi network. To use STA Mode, select it, then set the SSID and Password for the network you are joining. When all of your selections are made click on *Apply*. SAM will restart and join the network. The new settings will be stored in SAM's memory and will remain there until the settings are changed.

STA SSID: Select the network you wish to join and enter the SSID for that network.

STA Password: Enter the *Password* for the network you have selected to join.

STA Use DHCP: Turn this off ONLY if you want to set the IP address manually.

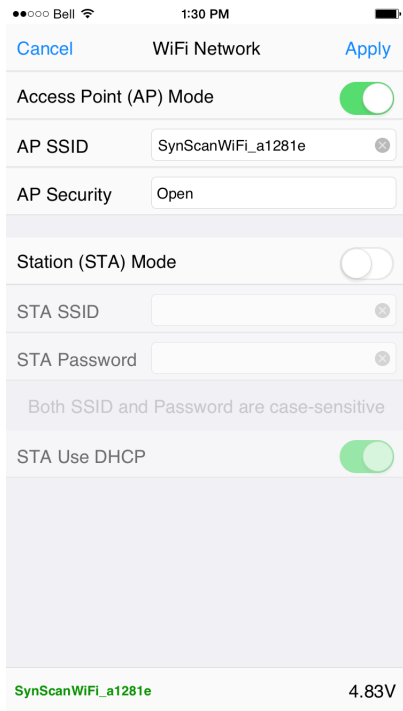

●●○○ Bell 1:30 PM 🔋

Cancel WiFi Network Apply

Access Point (AP) Mode

AP SSID

AP Security

Station (STA) Mode

STA SSID

STA Password

Both SSID and Password are case-sensitive

STA Use DHCP

SynScanWiFi_a1281e 4.83V

Network Troubleshooting

Re-establish WiFi Connection

The WiFi connection to SAM will disconnect if either the SSID or Password is modified. If you lose your WiFi connection please follow the procedures to reconnect your device to SAM as outlined on page 8.

Restore SAM to Factory WiFi Settings

If you have forgotten the Password or are having trouble establishing a WiFi connection then you may need to restore SAM to factory settings. Please refer to the procedures in Appendix VI: How to Restore Factory WiFi Settings. Note: You will need to re-establish your WiFi connection after restoring SAM to its factory WiFi settings.

Appendix I: Advanced Polar Alignment Procedures

As you increase the focal length of your camera lens and/or the exposure length of your photos you also increase the need to make your polar alignment more precise. The sign that you need to increase its precision is elongation of the stars in your images. Errors in polar alignment cause stars to drift off of the path your camera is making and onto new sets of pixels on the camera sensor. The result is seen as streaks where pinpoint star images should reside.

Fortunately, SAM is equipped with accessories to make very precise polar alignments. The Polar Scope is the most important of these as it provides you with a clear view of Polaris in the North and the Sigma Octanis group in the South. Further, the Star Adventurer mini Console provides a *Polar Clock* function to guide your polar alignment with remarkable precision.

NOTE: A Polar Scope is REQUIRED for the Advanced Alignment Procedures.

The *Equatorial Wedge* is not a requirement for the Advanced Polar Alignment Procedure but it is a HIGHLY RECOMMENDED accessory. The fine altitude and azimuth adjustment knobs on the *Equatorial Wedge* make precision pointing of SAM much easier than with the comparatively coarse adjustment resolution of a tilt/pan head or ball mount.

In the Southern Hemisphere there is the added difficulty of getting an initial, coarse polar alignment due to the lack of naked-eye stars in the vicinity of the South Celestial Pole. We include in the *Advanced Polar Alignment Procedure for the Southern Hemisphere* section a detailed procedure for achieving an initial alignment that will be sufficient to get the Sigma Octanis group into the field of view of your Polar Scope. From that point, it is a simple matter to achieve a very precise alignment by matching the view in the polar scope eyepiece to the view given by the *Polar Clock* Utility provided in the Star Adventurer mini Console.

NOTE: Because the *Equatorial Wedge* is such a highly recommended option



Star trails can make beautiful pictures, but only when they are intended! SAM eliminates trailing over long exposures to give you pin point star images.

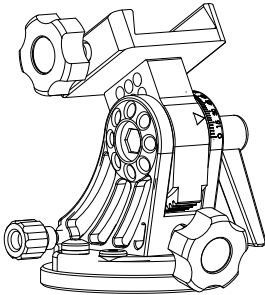
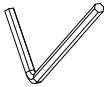
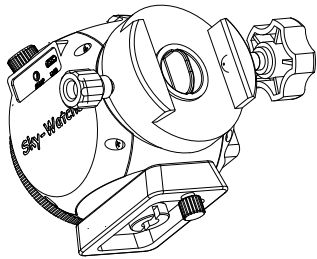

the following sections assume that you are using one. If you are not, you can still follow the procedures, but by making the indicated adjustments with your tilt/pan head or ball mount. We also highly recommend the *Fine-Tuning Mounting Assembly* as it enables you to perform the advanced polar alignment procedures with your photographic payload already attached to SAM and without the need to remove the polar scope once the procedure is done.

Advanced Polar Alignment for the Northern Hemisphere

Start by Achieving a Coarse Polar Alignment

1. Attach the *Equatorial Wedge* (wedge) to your tripod via the 3/8 inch mounting bolt (or using the 1/4 inch thread adapter if required).
2. Attach SAM to the *Equatorial Wedge*.
3. Level the tripod so that the bubble level on the wedge is centred. A level tripod is not a strict requirement, but it does make subsequent adjustments easier.
4. Turn the *Latitude Adjuster* to match the latitude of your location. This will angle SAM to the correct level to obtain your coarse polar alignment. You can use the Star Adventurer mini Console to get your latitude if the GPS function of your phone is enabled.
5. Look through the *Polar View Finder* and adjust your *Altitude* and *Azimuth Knobs* until you can see Polaris inside the boundaries of the view port. Note that if SAM is powered up you can illuminate the *Polar View Finder* LED by turning it on in the Star Adventurer mini Console, or quickly pressing and releasing the power button.

Once you can see Polaris in the view finder you are ready to install the *Polar Scope* and fine-tune your polar alignment with the *Polar Clock* function.

Setting Up the Polar Scope

Carefully remove the *Rear Mounting Plate* from the back of SAM and fully insert your *Polar Scope* into the exposed hole. If you have set things up correctly to this point, you should be looking directly north when looking through the *Polar Scope*.

Attach the *Polar Scope Illuminator* to the other end. This will help make the reticule pattern in the *Polar Scope* eyepiece more visible in dark conditions. Adjust the intensity of the illuminator by turning the dial. Make it bright enough to see the reticule pattern, but not so bright as to wash out your view of Polaris.

Rotate the *Polar Scope* so that the “0” label on the reticule pattern is at the 12 o’clock position (i.e., at the top). When positioned correctly 3 will be seen at the right, 6 and the bottom and 9 to the left.

Using the *Altitude* and *Azimuth Adjustment Knobs* on the wedge, adjust the view in your *Polar Scope* until you can see Polaris in the field of view. It can be anywhere in the field of view at this point. You will adjust to its exact location in a moment.

Using the Polar Clock Utility to Fine-Tune Your Polar Alignment

Now tap on the *Polar Clock Utility* in the *Main Menu* of the Star Adventurer mini Console. Tap on *Northern Hemisphere* if it is not already selected.

The app shows you a drawing that matches the view in the *Polar Scope*. Note the position of the small black dot. It represents Polaris and shows where Polaris should be located relative to the NCP at the time of your session. Turn your *Altitude* and *Azimuth Adjustment Knobs* until Polaris as seen in the view finder of your *Polar Scope* matches the position of the black dot. You are now precisely polar aligned with the NCP (represented by the intersection at the centre of your field of view) and can increase the the focal length of your lenses and/or exposure times of your photos with confidence.

Carefully remove the *Polar Scope Illuminator* and *Polar Scope* making sure that you do not disturb the position of the tripod. Now you can attach your

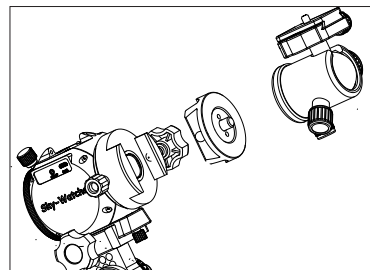
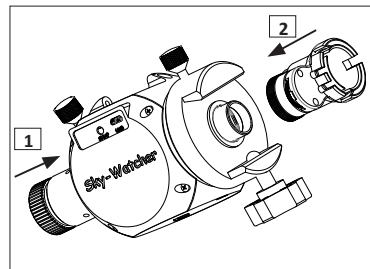

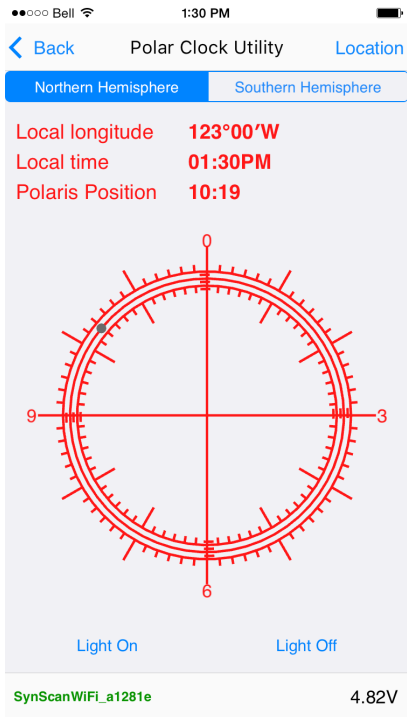

camera gear (ball head, camera). NOTE: If you are using the optional *Fine-Tuning Mounting Assembly* you can perform the polar alignment procedure with all of your gear already mounted.

Connect your camera to SAM via the SNAP control port using the appropriate interface cable for your brand of camera. Power up your equipment and you are ready to go!

Using the Optional Fine-Tuning Mounting Assembly

You can remove the need for a ball mount by using the *Fine-Tuning Mounting Assembly*. This assembly attaches to the *Saddle* and permits adjustments in the declination axis – the axis that runs perpendicular to SAM's rotational axis (known as the Right Ascension, or RA axis, in astronomy terms). Freedom to move your camera on the declination axis lets you point it to any location in the sky, just as the ball mount does. But the *Fine-Tuning Mounting Assembly* is much more than just an alternative to using a ball mount.

One of its biggest advantages is that it enables you to increase the payload of your imaging equipment by using a counter balance system. You can use larger, heavier lenses – or even use two cameras at a time.

With the *Fine-Tuning Mounting Assembly* you can even attach a small telescope to SAM for extended viewing of celestial objects held steady in the eyepiece by SAM's continuous tracking ability.

But maybe the biggest advantage of the *Fine-Tuning Mounting Assembly* is that you can leave your *Polar Scope* in place and perform the advanced polar alignment procedure even with your entire photographic payload in place. This greatly reduces the likelihood disturbing the precision polar alignment when adding equipment after the procedure has been performed.

To install the *Fine-Tuning Mounting Assembly* please follow the directions in Appendix IV.

Advanced Polar Alignment Procedure for the Southern Hemisphere

Northern observers/photographers have a great advantage when it comes to performing a polar alignment. They have the naked-eye star Polaris situated just 2/3 of a degree from the North Celestial Pole. This makes a quick alignment of an equatorial device like SAM very easy to accomplish. Just find Polaris and point SAM so that you can see Polaris in the field of view of the *Polar Finder* view port.

Unfortunately there are no bright reference stars in the immediate vicinity of the SCP, so the procedure to obtain a polar alignment is a bit more involved. However, there is a small group of stars near the SCP that, while invisible to the naked eye, can be seen in your *Polar Scope*. Once you have this group in view, a precision polar alignment is just as easy to accomplish in the southern hemisphere as it is in the north, thanks to the *Polar Clock* function included in the Star Adventurer mini Console.

First Install the Polar Scope [Refer to the photos on page 32.]

Carefully remove the *Rear Mounting Plate* from the back of SAM and insert your *Polar Scope* into the exposed hole. Attach the *Polar Scope Illuminator* to the other end. This will help make the reticule pattern in the *Polar Scope* eyepiece more visible in dark conditions. Adjust the intensity of the illuminator by turning the dial. Make it bright enough to see the reticule pattern, but not so bright as to wash out your view of the faint stars near the SCP.

Performing a Coarse Polar Alignment in the Southern Hemisphere

The goal of the coarse polar alignment is to get your *Polar Scope* aimed near enough to the SCP that you will be able to see a small group of four stars within its field of view. We refer to these as the Sigma Octanis group, with Sigma Octanis being the slightly brighter of the four, and always the one that is nearest the SCP as the group rotates about the SCP over the course of 24 hours.

6. Attach the *Equatorial Wedge* (wedge) to your tripod via the 3/8 inch mounting bolt (or using the 1/4 inch thread adapter if required).
7. Attach SAM to the *Equatorial Wedge*.

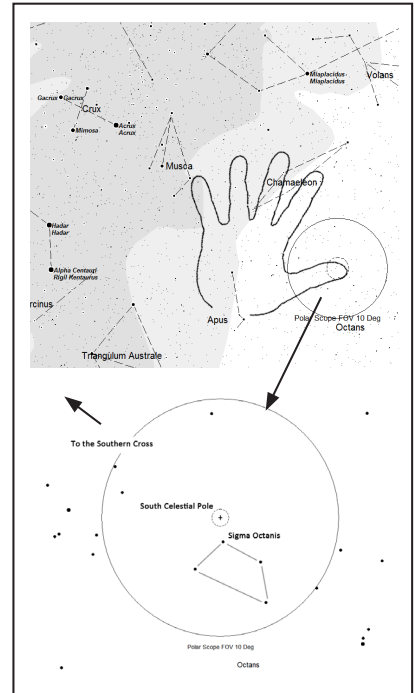

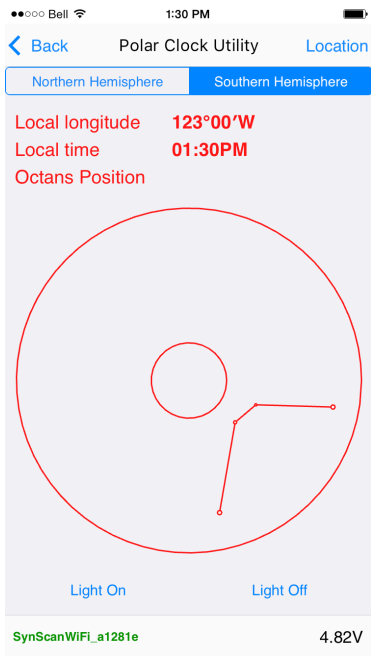

- Level the tripod so that the bubble level on the wedge is centred. A level tripod is not a strict requirement, but it does make subsequent adjustments easier.
- Turn the *Latitude Adjuster* to match the latitude of your location. This will angle SAM to the correct altitude to obtain your coarse polar alignment. You can use the Star Adventurer mini Console to get your latitude in *Settings > Location*.
- Find Acrux, then following a line from it to alpha Muscae, locate the next brightest star, gamma Muscae. If you were to draw a line through Acrux and gamma Muscae it would point very nearly to the SCP (see chart on previous page).
- Raise your hand at arms length and spread your fingers so there is about an extra finger space between each one. Put the tip of your little finger near gamma Muscae and tilt your hand so that the tip of your thumb would be on a line that connects it to gamma Muscae and Acrux.
- Point your polar scope into to the region where the tip of your thumb had been. If you pointed with reasonable accuracy, you should be able to see the Sigma Octanis group in the field of view of the *Polar Scope*. If not, keep making adjustments until you can using the altitude and azimuth adjusters on your wedge.

Using the Sigma Octanis Clock Utility

Once you can see the Sigma Octanis group in your *Polar Scope* field of view you are ready to fine-tune your polar alignment to the SCP.

- Bring up the Star Adventurer mini Console and tap on the *Polar Clock Utility*.
- Tap on *Southern Hemisphere* if it is not already selected. This will bring up a representation of the reticule in your *Polar Scope*.
- Rotate your *Polar Scope* to match the view in the *Polar Clock* utility. That is, rotate it so that the representation of the Sigma Octanis group in your *Polar Scope* has the same orientation as shown in the *Polar Clock* utility.
- Using the fine-tuning knobs on your wedge adjust it until the stars of the Sigma Octanis group as seen in the *Polar Scope* match their representations as shown in the app.

Appendix II: Calibrating the Polar Scope

For the highest precision it may be necessary to align the reticule in your *Polar Scope* before performing a polar alignment. This simple calibration procedure will ensure that your polar alignments are done to the highest possible level of precision.

First, check to see that your *Polar Scope* requires calibration. It may be just fine right out of the box, so do this simple test before attempting the calibration procedure:

1. With your *Polar Scope* mounted in SAM aim it at a distant object (preferably at least 100 metres away) that will not change its location. A street light or distant chimney is a good choice.
2. Align the distant target with the central cross hair in the *Polar Scope* reticule.
3. Rotate the *Polar Scope* 180 degrees while keeping everything else still.

If the distant target is still under the central cross hair, or if it has barely moved from that point, then **YOU DO NOT NEED TO CALIBRATE** your polar scope.

If the distant target has “moved away” from the cross hair significantly, then you should align the reticule to the optical axis of your *Polar Scope*.

Aligning The Polar Scope Reticule to the Polar Scope Optical Axis

If a calibration is required you will need a 1.5 mm Allen wrench to perform the following steps. Check your local hardware store if you don't have one on hand.

The *Polar Scope* reticule is held in place by the three Allen screws around the perimeter of the eyepiece. Consequently, you should not completely loosen any of these screws as the reticule will lose its support and no longer be adjustable. If this happens you will need to unscrew the eyepiece from the polar scope, manually centre the glass reticule as best you can, then reinsert the screw that had lost contact.

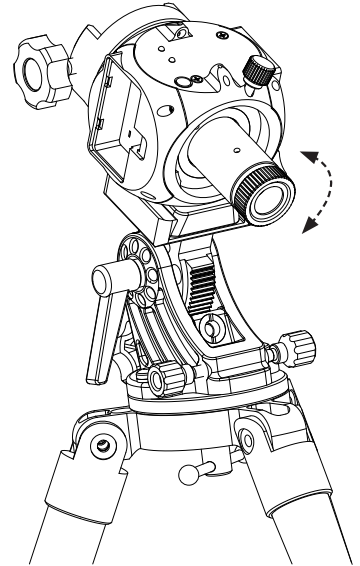

Aim your polar scope at a distant target then rotate the Polar Scope 180 degrees so that the lock knob is on the opposite side. Next, check the position of your distant target in the eyepiece. If it has moved off centre significantly you will need to calibrate your polar scope reticule.

Note how the orientation of the reticle changes when Polar Scope is rotated 180 degrees.

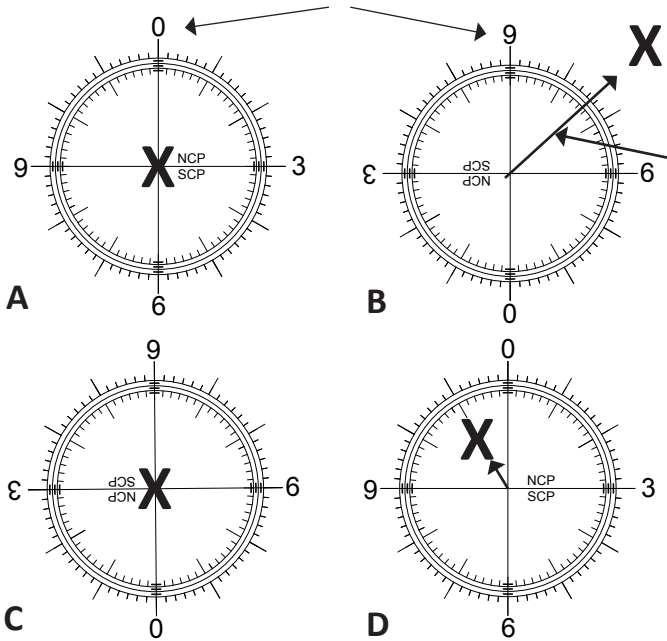

Adjust reticle until target appears here

Explanation of the Figures

A: Following tripod and/or wedge adjustments SAM has been aimed so that the distant target (X) falls under the central cross of the reticle pattern.

ACTION: Now Rotate the Polar Scope 180 degrees.

B: After rotation the target appears displaced due to misalignment of the polar scope reticle.

ACTION: Adjust the reticle using the three Allen screws (see page 38) until 1/2 of the error has been corrected.

C: Using the tripod and/or wedge adjustments re-centre the target under the cross hair.

ACTION: Rotate the Polar Scope 180 degrees (back to the original starting position).

D: Note any deviation of the target. If any significant deviation remains repeat the steps starting at A.

These figures represent the view through the polar scope when a target is initially centered (A), after Polar Scope has been rotated 180 degrees (B), after the reticle adjustment has been made and SAM has been re-centered on the target (C), and the target displacement after the second 180 degree rotation. There is a bit of displacement left as shown here, but one more iteration of the reticle alignment is likely all that would be needed to remove it.

Continuing from Step 3 above, note the deviation of your target from the central cross hair. To align your reticule you need to move it so that 1/2 of the error is corrected.

Locate the three small Allen screws around the perimeter of the *Polar Scope* eyepiece. You are going to tighten/loosen each one so that the cross hair in the reticule is positioned 1/2 way to the target in its deviated position.

4. Choose one of the screws and loosen it 1/4 turn. Note the movement of the cross hair. If it moves in the correct direction, tighten the two other screws about 1/4 turn each, then loosen the original screw again.
5. With each loosening/tightening of the opposing screws the cross hair will move. Continue until it is positioned at a point that is half way out to the target at its maximum deviated position. Now, gently tighten all three adjustment screws.
6. Adjust the tilt/pan head, ball head or equatorial wedge to place your target back under the cross hair. Now, rotate SAM 180 degrees in the opposite direction and note the location of your target relative to the cross hair.
7. If the target has displaced again, repeat steps 4 through 6. Perform the adjustments until the target no longer moves from beneath the cross hair when SAM is rotated through 180 degrees.

Remember:

- First verify that your *Polar Scope* requires calibration before starting the calibration adjustments! When adjusting the Allen screws, always proceed by loosening one screw then tightening the other two gently.
- Do not loosen one screw completely or loosen more than one screw at a time as the reticule may lose its support and become nonadjustable.
- To make things easier, perform the calibration during the daytime.

The three reticule adjustment screws are equally spaced around the perimeter of the polar scope near the eyepiece. (NOTE: Two of the screws are hidden from view in this photo.)

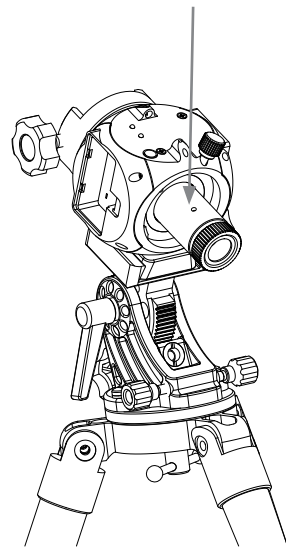

CAUTION: DO NOT over tighten the screws as you may crack the glass reticule inside the eyepiece of the polar scope.

Appendix III: The Optional Equatorial Wedge

If you plan to do a lot of astrophotography with SAM then you should seriously consider purchasing the *Equatorial Wedge* (wedge). This accessory makes the fine pointing control that is necessary for polar alignment procedures much more easily accomplished than using a standard tilt/pan head or ball mount.

The *Equatorial Wedge* includes the following key parts:

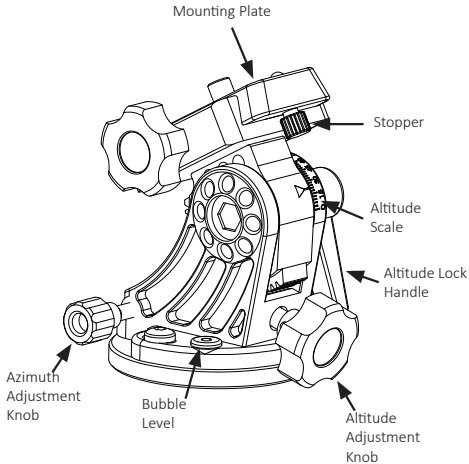

Mounting Plate: The *Mounting Plate* includes a 1/4 inch threaded bolt for attaching a camera or standard camera accessory, such as a ball mount.

Stopper: The *Stopper* acts as a safeguard against your camera payload slipping out of the *Saddle* of the *Equatorial Wedge* should you let go of it before tightening the *Mounting Plate Locking Knob*.

Azimuth (Horizontal) Adjustment Knob: This knob enables fine pointing of the wedge in the right and left directions (azimuth directions). It is especially useful when making fine adjustments for the *Easy* and *Advanced Polar Alignment Procedures*.

Altitude (Vertical) Adjustment Knob: This knob enables fine pointing of the wedge in the up and down (altitude) directions. It is especially useful when making fine adjustments for the *Easy* and *Advanced Polar Alignment Procedures*.

Altitude Scale: This scale indicates the altitude setting of the wedge. Note that for polar alignment procedures, the altitude of your wedge is equal to the latitude of your observing site if your wedge and tripod are set to level.

Bubble Level: A built-in level to assist you in setting your tripod and wedge to level. Note that a perfectly level tripod is not a requirement for using SAM in equatorial mode, but it does make the polar alignment adjustments a bit easier.

Altitude Lock Handle: Loosen this handle slightly before making latitude adjustments, then re-tighten when finished.

Appendix IV: The Fine-Tuning Mounting Assembly

The *Fine-Tuning Mounting Assembly* provides more convenience and control for mounting your photographic payloads. The *Fine-Tuning Element* gives you pointing control for horizontal movements, and for Declination adjustments when SAM is used in its polar-aligned equatorial mode. Use its adjustable clutch to make large changes in pointing directions, or make precise adjustments with its fine-tuning control knob.

One of the most useful features of the *Fine-Tuning Mounting Assembly* is that it lets you perform the advanced polar alignment procedure with your camera gear already in place. You no longer need to remove the *Polar Scope* after the procedure is completed. This greatly reduces the risk of bumping SAM out of alignment, which can happen when adding your camera gear after the polar alignment procedure has been done.

You can also use more gear with the *Fine-Tuning Mounting Assembly*. Add the optional SAM *Counter Weight* set and increase SAM's payload capacity to 4 kilograms! That's enough to carry a small telescope, so you can use SAM as an equatorial tracking mount for visual astronomy!

Or, use the *Fine-Tuning Mounting Assembly* to mount a second camera. Just remove the *Fine-Tuning Element* to reveal a second mounting screw. Attach a second ball mount and camera and double your photographic productivity!

With its versatile design the *Fine-Tuning Mounting Assembly* is a must-have accessory, particularly if you are going to use SAM extensively for astrophotography. Configure it as you like to make your outings more productive.

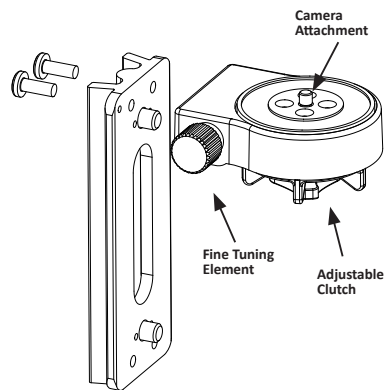

The *Fine-Tuning Mounting Assembly* can be configured in different ways to give you all sorts of configuration options.

SAM Has Many Possible Configurations

SAM can be configured with your ball mount, tilt/pan head, camera and tripod in many ways. For *Regular* and *Long-Exposure Time-Lapse* videos all you need to do is mount SAM to your tripod and your camera to SAM. Using a ball mount between SAM and the camera is highly recommended as it gives you much more control over your compositions.

The most recommended configuration for *Astrophotography* and *Astro Time-Lapse* is shown below and to the right. Here, the *Equatorial Wedge* is mounted to the tripod. SAM is attached to the wedge via the supplied mounting adapter, and a ball mount (see below) is then attached to SAM.

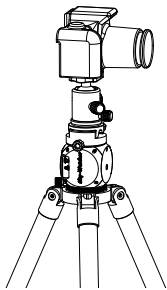
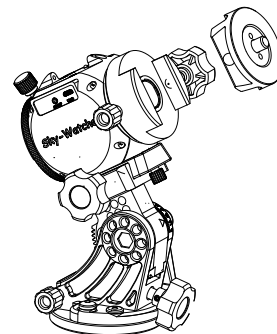

SAM configured for Regular and Long Exposure Time-Lapse Videos

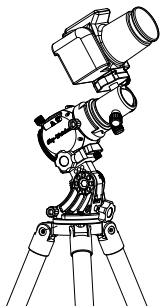

SAM configured for Astrophotography and Astro Time-Lapse Videos with and without the Fine-Tuning Mounting Assembly

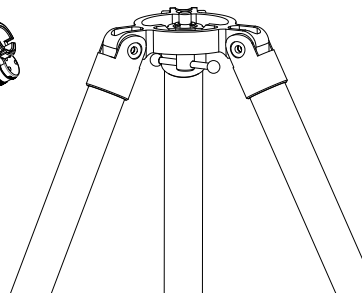
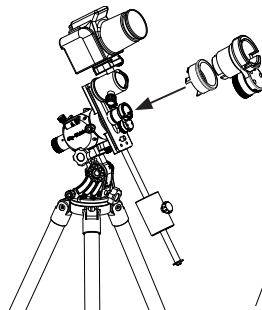

A ball mount is a necessary item for astrophotography as it permits you to aim your camera to any location in the sky.

Appendix V: Firmware Upgrade Procedure

From time to time we may make improvements to SAM's firmware. To update the firmware you will need to download the firmware loader program as well as the firmware update file. Both are available at the Sky-Watcher website in the downloads section. Follow the steps below to update the firmware:

1. Go to www.skywatcher.com and download the "Motor Controller Firmware Loader" V1.63 or higher from the Downloads page. You will need this program to load your firmware updates.
2. Find the most recent version of SAM's firmware and download it to your computer. Place it in the same folder as the firmware loader program.
3. Connect SAM to the computer with a micro USB cable. If you have not connected SAM to your computer before, wait a few moments for the drivers to load.
4. Press and hold SAM's Power Button to turn on the power.
5. Run the Motor Controller Firmware Loader and select the firmware file you downloaded.
6. Select "auto-detect COM port", then click on "Update". Please do NOT turn off the power while updating the firmware. After about 25 seconds, the program will display "Update Complete. Turn off power".
7. If you didn't select "auto-detect COM port", or you have other devices connected to the same computer, please manually enter the COM port for SAM as indicated in your Device Manager. Then click on "Update".
8. Press and hold the power button for about 5 second to turn off the power. The next time you power up SAM the new firmware will take effect.

If you encounter a power loss during the firmware update, restore the power then repeat Steps 3 to 7.

Appendix VI: How to Restore Factory WiFi Settings

From time to time you may need to reset SAM to its factory WiFi settings. For instance, if you accidentally enter any incorrect WiFi settings you may need to “reboot” SAM by restoring the factory defaults. To reset SAM to the factory WiFi settings follow the procedures listed below:

1. Power down SAM by holding the power button for about 5 seconds. Let go once the red LED goes out.
2. Press and hold the power button for about 10 seconds until the red LED starts to blink slowly. This indicates the start of the boot loader mode.
3. The boot loader will restore the factory default with the WiFi SSID set to SynScanWiFi_xxxxxx. No password will be required.
4. Power down SAM by holding the power button for about 5 seconds until the red LED goes out.

The next time you power SAM up it will start with the factory WiFi settings.

Note: When the power button is pushed and held for more than 9 seconds, or when a firmware upgrade is to be done, SAM will enter boot loader mode and the factory default WiFi settings will be restored. If you were using other than the default settings you will need to go back to the WiFi settings screens in the Star Adventurer mini Console to re-enter your settings preferences.

Appendix VII: SAM Product Specifications

Product Type	Ultra compact equatorial tracking platform
Regions	For Northern and Southern hemispheres
Functions	Astronomical Tracking, Camera Control and Time-Lapse Video Creation
Tracking Modes	Sidereal Rate, 1/2 Sidereal Rate, Solar, Lunar and Manual
Payload	Up to 3 kg
Wheel Gear	36 mm dia. 72 teeth aluminum alloy
Worm Gear	11 mm dia. High tension brass
Motor drive	Precision DC Servo
Built-in accessory	WiFi with selectable modes
Free App	Free control App for Android and iOS phones
Polar scope (optional)	Approximately 10° field for precision polar alignment to NCP and SCP
Power	Internal: 2 x AA batteries; External via micro USB
Duration of operation	Up to 24 hour with 2 x AA batteries
Temperature Range	-10 ° ~ 40 °C
Dimensions	76mm x70mm x 103 mm
Weight	0.65 kg
Mounting Connections	Dual 3/8" threaded socket (or 1/4" with included adapter)

Notice

Sky-Watcher reserves the right to change the specifications of the hardware and software described in this manual at any time and without prior notice.

Sky-Watcher cannot be held liable for any damage resulting from the inappropriate use of this product.

While every effort has been made to ensure that the information in this manual is accurate and complete, any errors you might find should be reported to Sky-Watcher.



Sky-Watcher®

Be amazed.